

**ORDINANCE NO. – F-1264**

**AN ORDINANCE AMENDING THE PLANNED UNIT DEVELOPMENT  
PERTAINING TO SIGNAGE FOR THE WHEATON NORTH COMMONS PROJECT**

WHEREAS, on February 21, 2006, the Wheaton City Council approved Ordinance No. F-1138 “AN ORDINANCE AMENDING THE WHEATON ZONING MAP BY GRANTING A SPECIAL USE PERMIT FOR PLANNED UNIT DEVELOPMENT ON PROPERTY COMMONLY KNOWN AS 0N625, 0N645, 0N659, 0N689 AND 1975 GARY AVENUE/ ARMBRUST PROPERTIES, LLC AND GARY AVENUE MEDICAL, LLC” (Original Ordinance); and

WHEREAS, the developer has submitted to the City a request to amend the Original Ordinance to modify the appearance and design of the proposed monument signs located at each drive entrance; and the City has determined that the requested amendment is a minor amendment and may be implemented without public hearing, pursuant to the provisions of Section 5.10.6 of the Wheaton Zoning Ordinance.

NOW THEREFORE BE IT ORDAINED, by the Mayor and City Council of the City of Wheaton, DuPage County, Illinois, pursuant to its home rule powers as follows:

Section 1: The real property, legally described in Exhibit A, which is attached hereto and incorporated herein, has been and continues to be zoned in the C-5 Planned Commercial zoning district classification, with a special use permit for a Planned Unit Development.

Section 2: Section 2 of the Original Ordinance shall be amended to include the use of the following plans in lieu of those described in the Original Ordinance: The plans entitled “Wheaton North Commons Site Plan, PD Approved Entry Wall / Signage, Proposed Entry Wall / Signage, prepared by PPKS Architects dated March 8, 2007”.

Section 3: In all other respects, the terms and conditions of the Original Ordinance are ratified and remain in full force and effect.

Section 4: This ordinance shall become effective after its passage, approval and publication in pamphlet form in the manner described by law.

Mayor

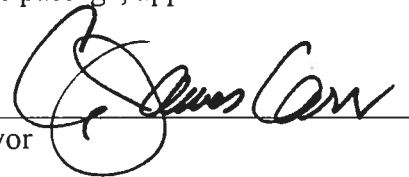

ATTEST:

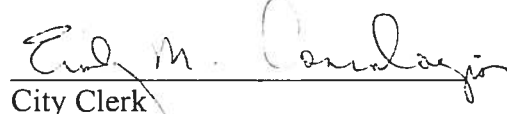
  
City Clerk

Roll Call Vote:

Ayes: Councilman Suess  
Councilman Bolds  
Councilwoman Corry  
Councilman Johnson  
Mayor Carr  
Councilman Levine  
Councilman Mouhelis

Nays: None

Absent: None

Motion Carried Unanimously

Passed: March 19, 2007  
Published: March 20, 2007

## Exhibit A

THAT PART OF THE NORTHEAST QUARTER OF SECTION 8, TOWNSHIP 39 NORTH, RANGE 10, EAST OF THE THIRD PRINCIPAL MERIDIAN, DESCRIBED BY COMMENCING AT THE NORTHWEST CORNER OF THE NORTHEAST QUARTER OF SAID SECTION 8 AND RUNNING THENCE SOUTH ALONG THE WEST LINE OF THE NORTHEAST QUARTER OF SECTION 8, 1092.2 FEET FOR A PLACE OF BEGINNING; THENCE CONTINUING SOUTH ALONG SAID LINE 178.3 FEET TO A POINT 33 FEET SOUTH OF THE NORTH LINE OF JEROME AVENUE EXTENDED; THENCE EAST PARALLEL WITH AND 33 FEET SOUTH OF THE NORTH LINE OF JEROME AVENUE EXTENDED 339.5 FEET; THENCE NORTH PARALLEL WITH THE WEST LINE OF WHEATON PARK TERRACE, 178.3 FEET; THENCE WEST 330.75 FEET TO THE PLACE OF BEGINNING IN DUPAGE COUNTY, ILLINOIS.

THAT PART OF THE NORTHEAST QUARTER OF SECTION 8 TOWNSHIP 39 NORTH, RANGE 10, EAST OF THE THIRD PRINCIPAL MERIDIAN, DESCRIBED BY COMMENCING AT THE NORTHWEST CORNER OF THE NORTHEAST QUARTER OF SAID SECTION 8 AND RUNNING THENCE SOUTH ALONG THE WEST LINE OF SAID NORTHEAST QUARTER, 665.7 FEET FOR A PLACE OF BEGINNING; THENCE EASTERLY PARALLEL WITH THE SOUTH LINE OF THE TRACT CONVEYED BY DOCUMENT 315804, 339.75 FEET; THENCE SOUTH PARALLEL WITH THE WEST LINE OF SAID NORTHEAST QUARTER, 128.3 FEET; THENCE WESTERLY PARALLEL WITH THE SAID SOUTH LINE OF THE PROPERTY CONVEYED BY DOCUMENT 315804, 339.75 FEET TO THE WEST LINE OF SAID NORTHEAST QUARTER; THENCE NORTH ALONG SAID WEST LINE, 128.3 FEET TO THE PLACE OF BEGINNING, IN DUPAGE COUNTY, ILLINOIS.

LOTS 1 AND 2 OF JOSEPH DIETER'S FIRST PLAT OF SURVEY OF PART OF THE NORTHEAST QUARTER OF SECTION 8, TOWNSHIP 39 NORTH, RANGE 10, EAST OF THE THRID PRINCIPAL MERIDIAN, REFERENCE BEING HAD TO THE RECORDING OF SAID PLAT ON MAY 3, 1950 AS DOCUMENT 591964, IN DUPAGE COUNTY, ILLINOIS.

THAT PART OF THE NORTHEAST QUARTER OF SECTION 8, TOWNSHIP 39 NORTH, RANGE 10, EAST OF THE THIRD PRINCIPAL MERIDIAN, DESCRIBED BY COMMENCING AT THE NORTHWEST CORNER OF THE NORTHEAST QUARTER OF SAID SECTION 8 AND RUNNING THENCE SOUTH ALONG THE WEST LINE OF SAID NORTHEAST QUARTER, 794 FEET FOR A PLACE OF BEGINNING; THENCE EASTERLY 339.75 FEET; THENCE SOUTH PARALLEL WITH THE WEST LINE OF SAID NORTHEAST QUARTER 128.3 FEET; THENCE WESTERLY, 339.75 FEET TO THE WEST LINE OF SAID NORTHEAST QUARTER; THENCE NORTH ALONG SAID WEST LINE 128.3 FEET TO THE PLACE OF BEGINNING, IN DUPAGE COUNTY, ILLINOIS.

P.I.N. 05-08-200-002, 05-08-200-003, 05-08-200-004, 05-08-200-005,  
05-08-200-006

The subject property is commonly known as 1975, 0N625, 0N645, 0N659 & 0N689 Gary Avenue, Wheaton, IL 60187.

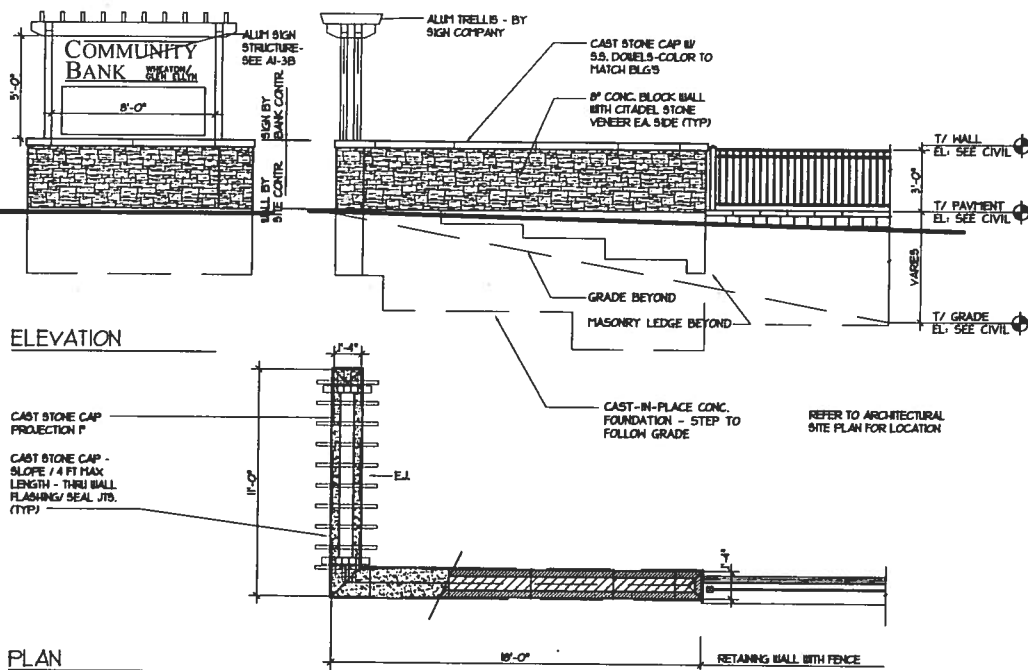
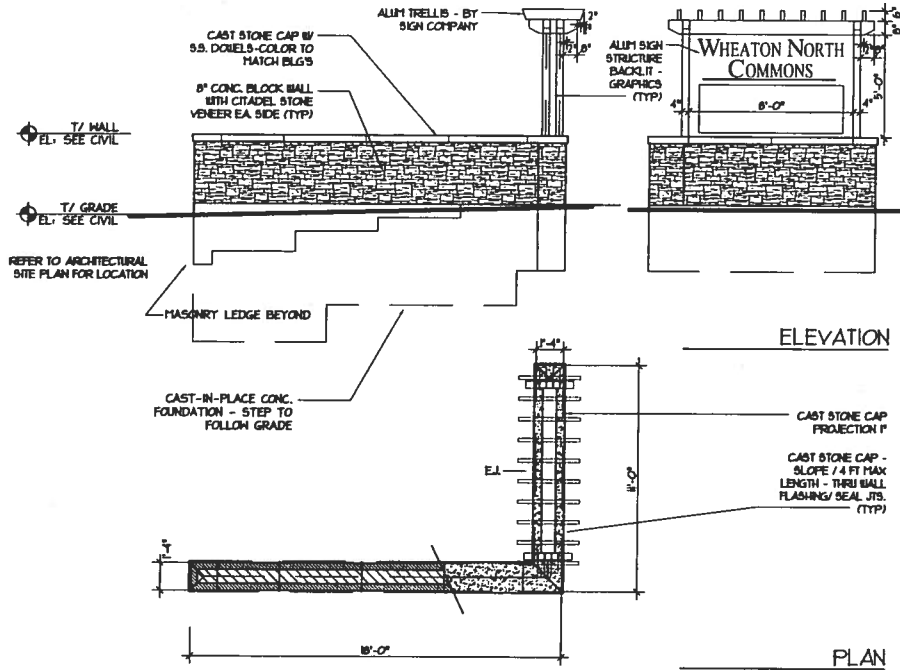

7 NORTH ENTRY WALL - DEVELOPMENT SIGN  
AI-2 SCALE: 1/4" = 1'-0"

6 SOUTH ENTRY WALL - DEVELOPMENT SIGN  
AI-2 SCALE: 1/4" = 1'-0"

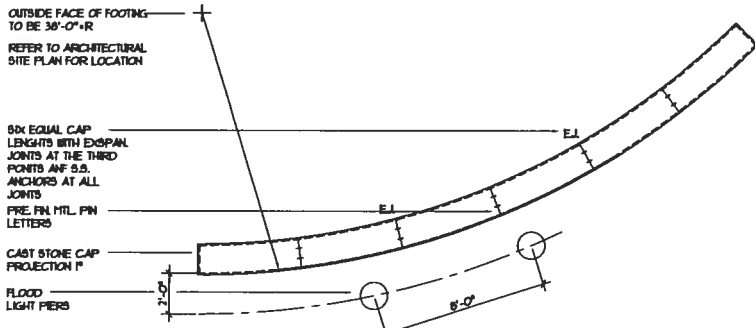
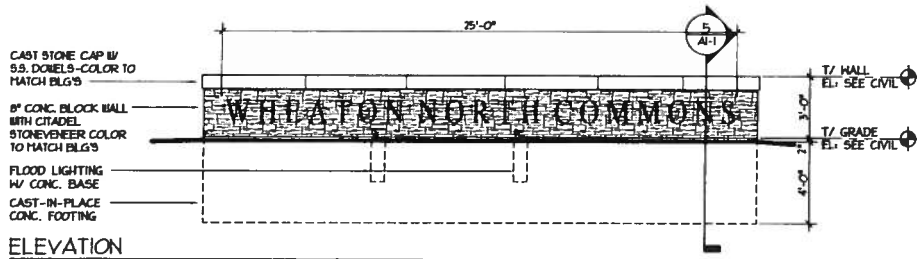

**1 NORTH ENTRY WALL**  
 AI-2 SCALE: 1/4"=1'-0"

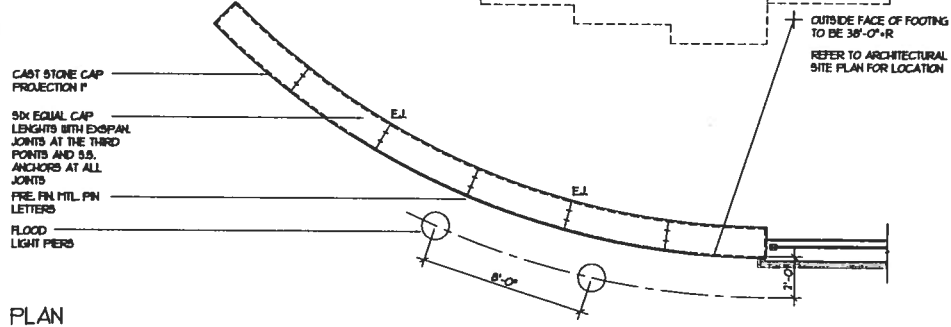
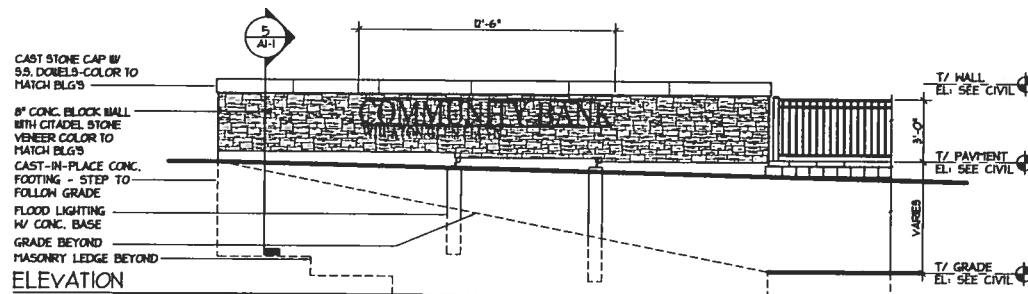

**6 SOUTH ENTRY WALL**  
 AI-2 SCALE: 1/4"=1'-0"

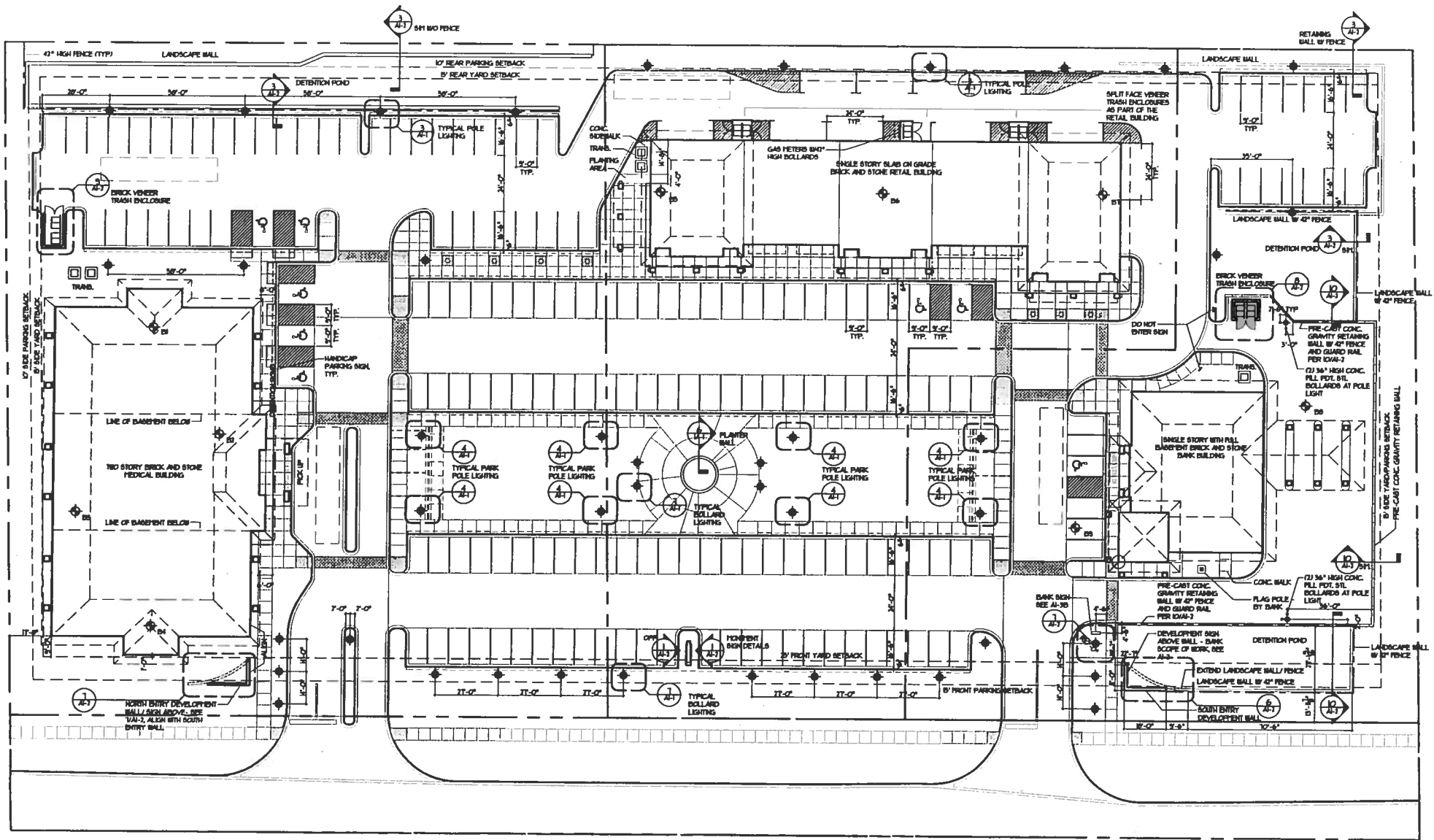

WHEATON NORTH COMMONS  
 WHEATON, ILLINOIS

SITE PLAN  
 SCALE: NOT TO SCALE

PPKS ARCHITECTS  
 08 March 2007